



Der Anhänger



SySTEMA[®]
the clever trailer program

SySTEMA[®]

the clever trailer program



FLAT BED TRAILER

payload L x W

gross vehicle weight (kg)

210 x 128 cm	750 / 850 / 1000 / 1300
210 x 153 cm	750 / 850 / 1000 / 1300
251 x 128 cm	750 / 850 / 1000 / 1300 / 1500 / 2000
251 x 153 cm	750 / 1000 / 1300 / 1500 / 2700
301 x 128 cm	1000 / 1300
301 x 153 cm	1000 / 1300 / 1500 / 2000 / 2700
301 x 183 cm	1500 / 2000 / 2700
401 x 183 cm	2000 / 2700 / 3000 / 3500
401 x 203 cm	2000 / 2700 / 3000 / 3500

great choice!



single axle



twin axle



PLATFORM TRAILER

payload L x W

gross vehicle weight (kg)

210 x 128 cm	750 / 1000
251 x 128 cm	750 / 1000 / 1300 / 1500 / 2000
251 x 153 cm	750 / 1000 / 1300 / 1500 / 2000
301 x 153 cm	1000 / 1300 / 1500 / 2000
301 x 183 cm	1500 / 2000 / 2700 / 3500
401 x 183 cm	2000 / 2700 / 3000 / 3500
401 x 203 cm	1800 / 2000 / 2700 / 3000 / 3500
511 x 213 cm	NEW 3500
611 x 213 cm	NEW 3500



single axle



twin axle

Tip!



A TRAILER according to your IDEAS.
HERE simply configure the trailer.

www.stema.de



► **EXTENSIONS**

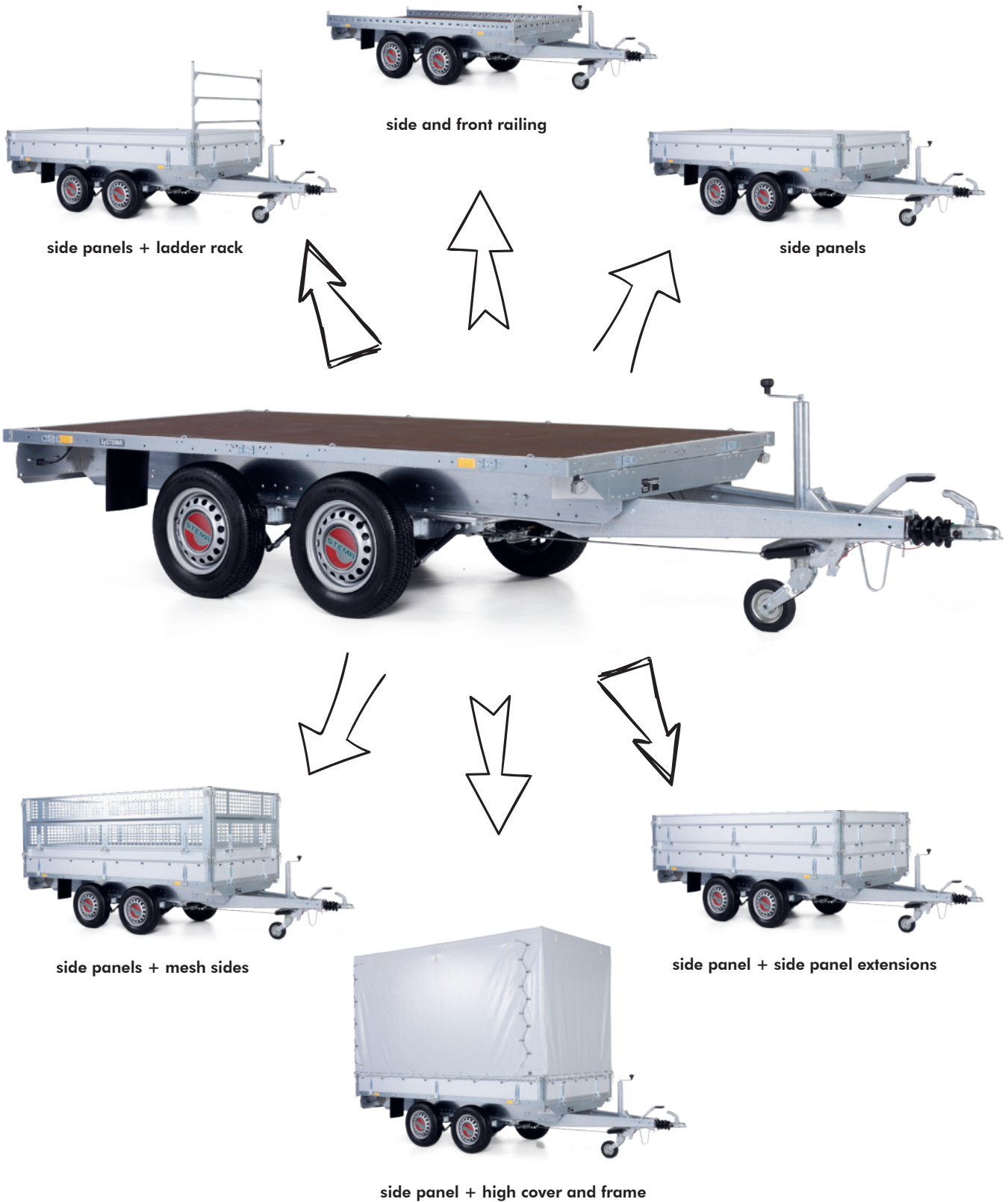

SySTEMA[®] XXL-TRANSPORTER

five and six meter long load area

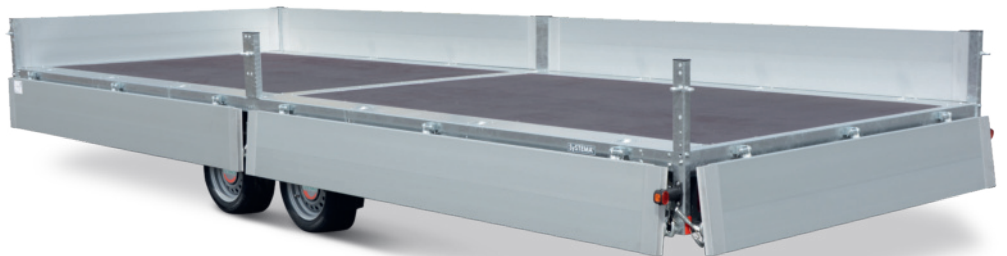

hinged on all sides!

SySTEMA[®] XXL - **standard equipment**

- ✓ twin axle with STEMA safety-V-drawbar
- ✓ overrun brake and jockey wheel*
- ✓ shock absorbers (100 km/h prerequisite)
- ✓ Oversized steel frame, welded & galvanized
- ✓ up to 14 lashing troughs, integrated in the frame
max. load: each 800 daN (kg), DIN EN 12640 *
- ✓ up to 14 additional lug nuts M10 for lashing *
- ✓ 4 additional steel sheets with slots for lashing
- ✓ the steel insert ist removable
- ✓ slip-resitant loading platform with waterproof multi-layer wooden floor 18 mm
- ✓ modern Multipoint V lighting with two back-up lights and two clearance lights
- ✓ 4 active side marker lights per side
- ✓ icense plate holder with door
- ✓ integrated compartment for the retrofitting of loading ramps
- ✓ 13-pin plug (EC-equipment)*

*depending on model



Construction: can only be upgraded with aluminum side panels and angle lever locks.

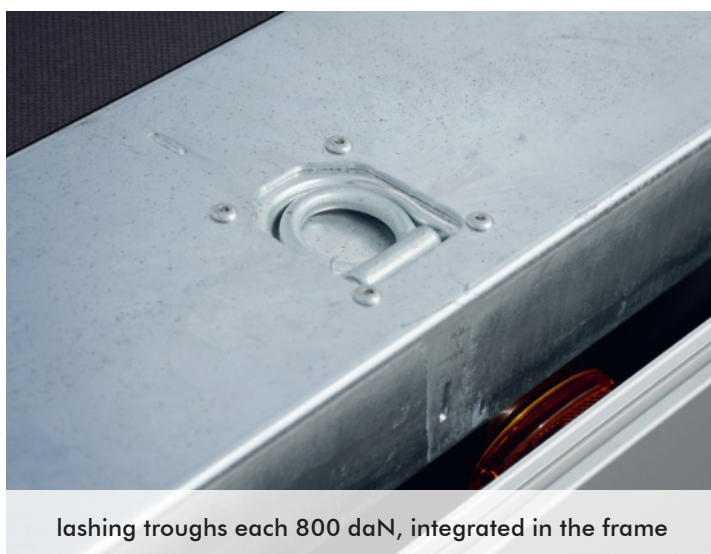

lashing troughs each 800 daN, integrated in the frame



steel sheets with slots and ring nuts



Der Anhänger

So many europallet fit on an SySTEMA XXL-Transporter:

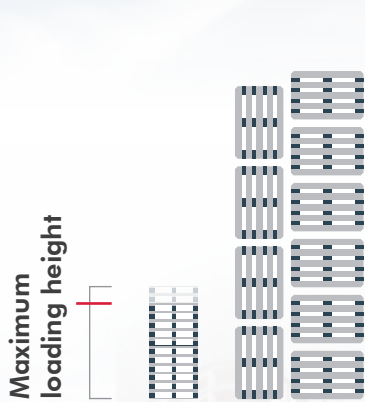

110 Stk.*

XXL transporter 5,11 m
 10 plots
 ca. 2593 kg payload

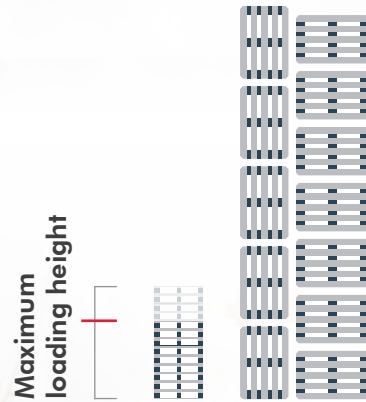

108 Stk.*

XXL transporter 6,11 m
 12 plots
 ca. 2497 kg payload

* Bei einer maximalen Ladehöhe PKW-Anhänger von 2 Metern und bei entsprechender Ladungssicherung. Mit einer Europalette nach EPAL-Richtlinie: Europalette EUR 1 mit 1200 mm x 800 mm x 144 mm (Länge/Breite/Höhe) und einem gemittelten Gewicht von 22 kg pro Palette. Alle Maße sind ca. Angaben. Irrtümer behält sich STEMA vor.



classic examples



with removable middle stanchions

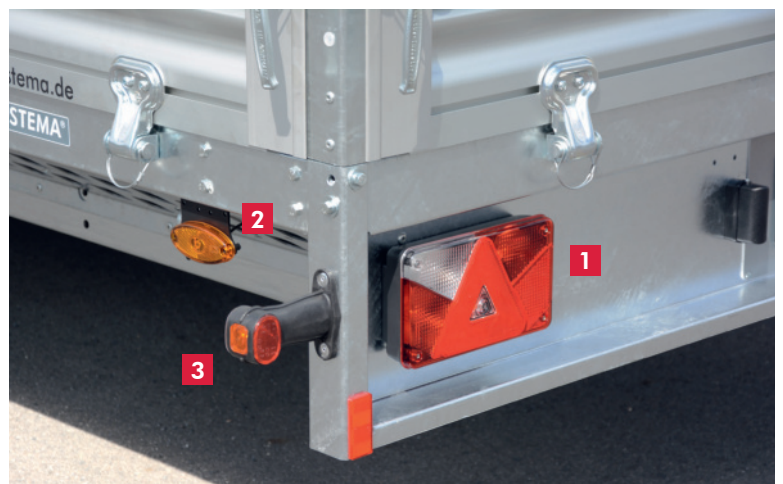

[1] Multipoint V lighting
 [2] side marker lights [3] clearance lights



Der Anhänger



Flexible.

Side panels are foldable to all sides or can be removed completely for unobstructed loading and unloading.*



* Depending on model

SySTEMA[®] - ALU TRANSPORTER



Our attention to detail makes us better

The new SySTEMA[®] – aluminum transporter was developed by users and professional. It is equipped with a lot of technical highlights and ingenious features that conventional models do not provide.

A nice amount of space

Handy corner plug-in possibilities for cover and frame as well as functional extensions like side panel extensions or mesh sides maximise your trailer loading height.



locking bolts are double-coated



sturdy steel hinges



Effective advertising

Design your trailer. On demand, we deliver your individually printed advertising cover according to your design proposal. Whether logo, slogan or photograph. In addition, we offer a wide range of colours for your cover.

📌 Your STEMA dealer will be happy to advise you.

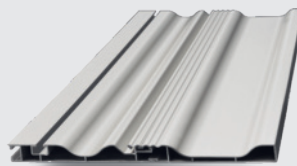

Strong & durable

The high quality eloxed aluminum side panels convince through their double chamber profile and high stability as well as durability.

📌 Wall thickness: 2,5 cm

Pictures are classic examples and partly contain accessories. Products are subject to continuous technical changes.

Sealed tight

STEMA refines each aluminum tailgate surface by means of the anodizing process. The resulting anticorrosive thin layer that is only 5 to 25 microns in thickness is practical the resulting matt gloss finish is stylish at the same time.

A lot of movement requires a lot of stability

Parts on the move need to be particularly stable. With our hinges and locks we pay particular attention to comfort and durability.



aluminum seal



locking bolts are adjustable



Der Anhänger



STAY FLEXIBLE



SySTEMA® standard equipment

- ✓ flat bed or platform trailer, single or twin axle
- ✓ tiltable drawbar with fastener *
(up to 750 kg gross vehicle weight)
- ✓ overrun brake and jockey wheel*
- ✓ shock absorbers *
- ✓ license plate holder with door
- ✓ integrated compartment for the retrofitting of loading ramps
- ✓ 4 to 8 lashing eyes, retractable in frame*
- ✓ attached lashing points to fixing covers and tie-down net
- ✓ slip-resistant loading platform with waterproof multi-layer wood floor
- ✓ shock-proof plastic mudguards
- ✓ perfect road performance by stable chassis with STEMA safety-V-drawbar
- ✓ robust rubber torsion beam axle with independent wheel suspensions
- ✓ maintenance-free wheel bearings
- ✓ modern Multipoint III lighting with back-up light
- ✓ 13-pin plug (EC-equipment)*
- ✓ axle, brake and electric by brand manufacturer
- ✓ quality brand tires

* depending on model





Easy.

The big cast steel anglelever locking devices can be operated fast and easily.

Sturdy.

Double-walled moulded side panels with GALVALUME® coating ensure a high stability and durability.

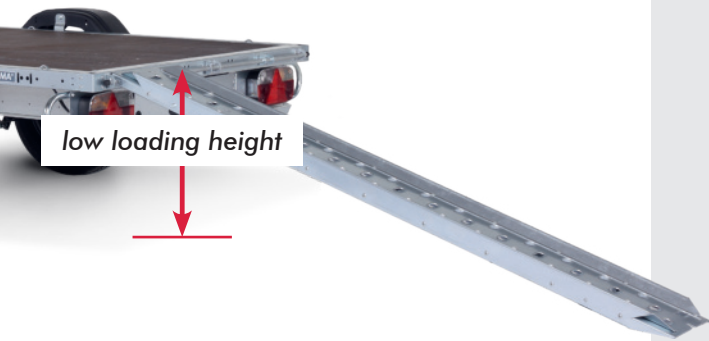

low loading height

BIGGER LOAD VOLUME

mesh sides



66 cm high

side panels & side panel extensions



70 cm high

side panels & mesh sides

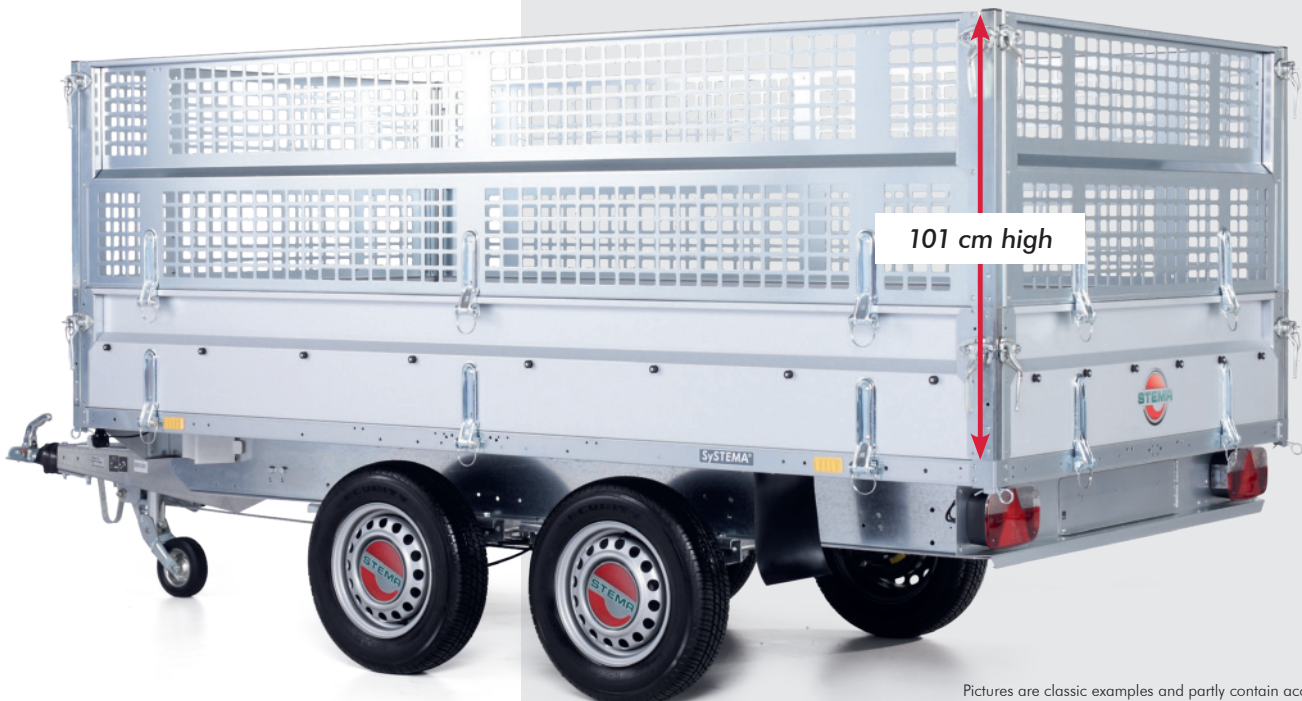

101 cm high



Der Anhänger



length: 198 cm

SURVEY OF ALL DETAILS

Clever stored

The tray for the loading ramps is already included in each SySTEMA® trailer. Aluminum or steel loading ramps are available as accessories. They are inserted right behind the license plate holder and can be safely and simply plugged in. This enables rapid loading at any place at any time.

Fast and safe

Due to the big and sturdy lashing eyes your load is in good hands and allows fast and ideal securing of your load. Practical coil springs on the bottom side ensure a rattle-free transport.



integrated tray for loading ramps

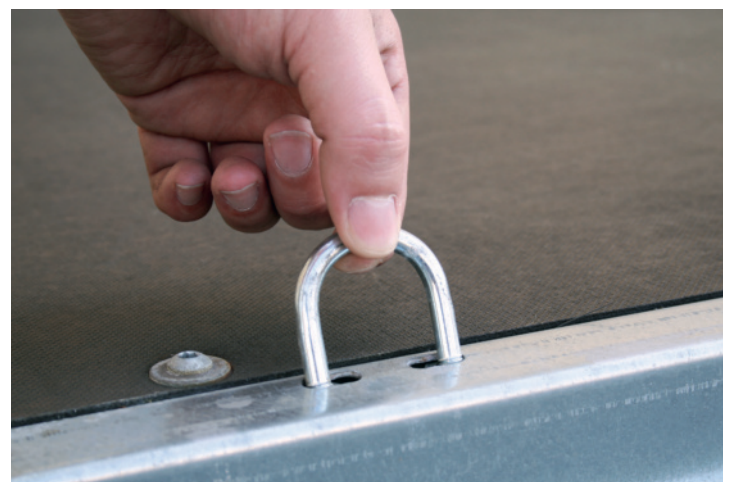

stable lashing eye



Loading capacity of loading ramps*
400 to 2100 kg per pair

* * depending on model. Please always observe the maximum load capacity of your trailer. Trailers and accessories reduce the maximum payload.



easy loading and unloading by all sides fold-down panels



large cubic capacity due to extra high side panels and mesh sides

Pictures are classic examples and partly contain accessories.
 Products are subject to continuous technical changes.

100 km/h prerequisite

All braked SySTEMA® trailers from 850 kg gross vehicle weight are standard equipped with shock absorbers of the brand manufacturer. These trailers can be directly registered at the registration office for 100 km/h.

Small features that make the difference

Moving parts are subject to particular wear. This is why we place such a focus on their stability and durability. All SySTEMA® trailers with side panels are equipped with robust strag hinges, locks and sturdy lashing eyes.



shock absorbers are standard equipment









locks and wide hinges

TECHNICAL DETAILS



SySTEMA® **flat bed trailer** - platform without extensions

internal dimensions L x W	gross vehicle weight (kg)	payload (kg) A	external dimensions L x W x H (cm) B	rim diameter (cm)	brake/ jockey wheel/ shock absorbers	model	article number
210 x 128 cm	single axle						
	750	602	309 x 173 x 59.5	33.02 (13")	- / - / -	STP O1 7.5-21-13.1	24203
	850	641	330 x 177 x 59.5	33.02 (13")	✓ / ✓ / ✓	STP O2 8.5-21-13.1	24204
	1000	788	330 x 177 x 59.5	33.02 (13")	✓ / ✓ / ✓	STP O2 10-21-13.1	24205
	1300	1078	330 x 177 x 59.5	33.02 (13")	✓ / ✓ / ✓	STP O2 13-21-13.1	24202
210 x 153 cm	single axle						
	750	573	309 x 198 x 59.5	33.02 (13")	- / - / -	STP O1 7.5-21-15.1	24206
	850	607	330 x 202 x 59.5	33.02 (13")	✓ / ✓ / ✓	STP O2 8.5-21-15.1	24207
	1000	754	330 x 202 x 59.5	33.02 (13")	✓ / ✓ / ✓	STP O2 10-21-15.1	24208
	1300	1064	330 x 202 x 59.5	33.02 (13")	✓ / ✓ / ✓	STP O2 13-21-15.1	24209
251 x 128 cm	single axle						
	750	588	350 x 173 x 59.5	33.02 (13")	- / - / -	STP O2 7.5-25-13.1	24220
	850	627	371 x 177 x 59.5	33.02 (13")	✓ / ✓ / ✓	STP O2 8.5-25-13.1	24212
	1000	773	371 x 177 x 59.5	33.02 (13")	✓ / ✓ / ✓	STP O2 10-25-13.1	24221
	1300	1067	371 x 177 x 59.5	33.02 (13")	✓ / ✓ / ✓	STP O2 13-25-13.1	24223
	1500	1243	371 x 177 x 59.5	33.02 (13")	✓ / ✓ / ✓	STP O2 15-25-13.1	24225
	twin axle						
	499	285	350 x 173 x 59.5	33.02 (13")	- / - / -	STP O1 4.9-25-13.2	24210
	750	536	350 x 173 x 59.5	33.02 (13")	- / - / -	STP O1 7.5-25-13.2	24211
	1500	1177	371 x 177 x 59.5	33.02 (13")	✓ / ✓ / ✓	STP O1 15-25-13.2	24224
	2000	1668	371 x 177 x 59.5	33.02 (13")	✓ / ✓ / ✓	STP O1 20-25-13.2	24222
251 x 153 cm	single axle						
	750	554	350 x 198 x 59.5	33.02 (13")	- / - / -	STP O1 7.5-25-15.1	24230
	1000	742	371 x 202 x 59.5	33.02 (13")	✓ / ✓ / ✓	STP O2 10-25-15.1	24231
	1300	1038	371 x 202 x 59.5	33.02 (13")	✓ / ✓ / ✓	STP O2 13-25-15.1	24232
	1500	1219	371 x 202 x 59.5	33.02 (13")	✓ / ✓ / ✓	STP O2 15-25-15.1	24233
	twin axle						
	1500	1147	371 x 202 x 59.5	33.02 (13")	✓ / ✓ / ✓	STP O2 15-25-15.2	24234
	2700	2321	371 x 202 x 59.5	33.02 (13")	✓ / ✓ / ✓	STP O2 27-25-15.2	24235





A Extensions and accessories are reducing the maximum payload.

B H = loading height (height of platform's upper edge)

TECHNICAL DETAILS



SySTEMA® flat bed trailer - platform without extensions

internal dimensions L x W	gross vehicle weight (kg)	payload (kg) A	external dimensions L x W x H (cm)		rim diameter (cm)	brake/ jockey wheel/ shock absorbers	model	article number
			B					
301 x 128 cm	single axle							
	1000	754	421 x 177 x 59.5		33.02 (13")	✓ / ✓ / ✓	STP O2 10-30-13.1	24240
	1300	1054	421 x 177 x 59.5		33.02 (13")	✓ / ✓ / ✓	STP O2 13-30-13.1	24241
301 x 153 cm	single axle							
	1000	718	421 x 202 x 59.5		33.02 (13")	✓ / ✓ / ✓	STP O2 10-30-15.1	24246
	1300	1015	421 x 202 x 59.5		33.02 (13")	✓ / ✓ / ✓	STP O2 13-30-15.1	24247
	1500	1172	421 x 202 x 59.5		33.02 (13")	✓ / ✓ / ✓	STP O2 15-30-15.1	24245
	twin axle							
	1500	1138	421 x 202 x 59.5		33.02 (13")	✓ / ✓ / ✓	STP O2 15-30-15.2	24248
	2000	1624	421 x 202 x 59.5		33.02 (13")	✓ / ✓ / ✓	STP O2 20-30-15.2	24249
	2700	2293	420 x 202 x 59.5		33.02 (13")	✓ / ✓ / ✓	STP O2 27-30-15.2	24250
301 x 183 cm	single axle							
	1500	1124	464 x 232 x 59.5		33.02 (13")	✓ / ✓ / ✓	STP O2 15-30-18.1	24278
	twin axle							
	2000	1563	464 x 232 x 59.5		33.02 (13")	✓ / ✓ / ✓	STP O2 20-30-18.2	24279
	2700	2252	464 x 232 x 59.5		33.02 (13")	✓ / ✓ / ✓	STP O2 27-30-18.2	24280
401 x 183 cm	twin axle							
	2000	1510	564 x 232 x 59.5		33.02 (13")	✓ / ✓ / ✓	STP O2 20-40-18.2	24160
	2700	2200	564 x 232 x 59.5		33.02 (13")	✓ / ✓ / ✓	STP O2 27-40-18.2	24161
	3000	2442	564 x 232 x 59.5		33.02 (13")	✓ / ✓ / ✓	STP O2 30-40-18.2	24162
	3500	2931	564 x 232 x 59.5		33.02 (13")	✓ / ✓ / ✓	STP O2 35-40-18.2	24163
401 x 203 cm	twin axle							
	2000	1475	564 x 232 x 59.5		33.02 (13")	✓ / ✓ / ✓	STP O2 20-40-20.2	24164
	2700	2159	564 x 232 x 59.5		33.02 (13")	✓ / ✓ / ✓	STP O2 27-40-20.2	24165
	3000	2406	564 x 232 x 59.5		33.02 (13")	✓ / ✓ / ✓	STP O2 30-40-20.2	24166
	3500	2888	564 x 232 x 59.5		33.02 (13")	✓ / ✓ / ✓	STP O2 35-40-20.2	24167

A Extensions and accessories are reducing the maximum payload.

B H = loading height (height of platform's upper edge)

TECHNICAL DETAILS



SySTEMA® platform trailer - platform without extensions

internal dimensions L x W	gross vehicle weight (kg)	payload (kg) A	external dimensions L x W x H (cm) B	rim diameter (cm)	brake/ jockey wheel/ shock absorbers	model	article number	
210 x 128 cm	single axle							
	750	605	338 x 135 x 64	25.40 (10")	- / - / -	SHP O1 7.5-21-13.1	24310	
	1000	776	348 x 135 x 67	25.40 (10")	✓ / ✓ / ✓	SHP O2 10-21-13.1	24311	
251 x 128 cm	single axle							
		750	576	379 x 134 x 64	25.40 (10")	- / - / -	SHP O1 7.5-25-13.1	24320
		1000	759	390 x 141 x 70	33.02 (13")	✓ / ✓ / ✓	SHP O2 10-25-13.1	24330
		1300	1055	390 x 141 x 70	33.02 (13")	✓ / ✓ / ✓	SHP O2 13-25-13.1	24331
	twin axle							
		750	565	380 x 134 x 64	25.40 (10")	- / - / -	SHP O1 7.5-25-13.2	24321
	1500	1138	390 x 141 x 70	33.02 (13")	✓ / ✓ / ✓	SHP O2 15-25-13.2	24332	
	2000	1677	390 x 141 x 70	33.02 (13")	✓ / ✓ / ✓	SHP O2 20-25-13.2	24333	
251 x 153 cm	single axle							
		1000	728	390 x 166 x 70	33.02 (13")	✓ / ✓ / ✓	SHP O2 10-25-15.1	24334
		1300	1026	390 x 166 x 70	33.02 (13")	✓ / ✓ / ✓	SHP O2 13-25-15.1	24335
		1500	1197	390 x 166 x 70	33.02 (13")	✓ / ✓ / ✓	SHP O2 15-25-15.1	24336
	twin axle							
		750	492	380 x 166 x 64	25.40 (10")	- / - / -	SHP O2 7.5-25-15.2	24323
	1500	1158	390 x 166 x 70	33.02 (13")	✓ / ✓ / ✓	SHP O2 15-25-15.2	24337	
	2000	1649	390 x 166 x 70	33.02 (13")	✓ / ✓ / ✓	SHP O2 20-25-15.2	24338	
301 x 153 cm	single axle							
		1000	690	440 x 166 x 70	33.02 (13")	✓ / ✓ / ✓	SHP O2 10-30-15.1	24350
		1300	978	440 x 166 x 70	33.02 (13")	✓ / ✓ / ✓	SHP O2 13-30-15.1	24351
		1500	1161	440 x 166 x 70	33.02 (13")	✓ / ✓ / ✓	SHP O2 15-30-15.1	24352
	twin axle							
		2000	1601	440 x 166 x 70	33.02 (13")	✓ / ✓ / ✓	SHP O2 20-30-15.2	24353



A Extensions and accessories are reducing the maximum payload.

B H = loading height (height of platform's upper edge)

TECHNICAL DETAILS



SySTEMA® platform trailer - platform without extensions

internal dimensions L x W	gross vehicle weight (kg)	payload (kg) A	external dimensions L x W x H (cm) B	rim diameter (cm)	brake/ jockey wheel/ shock absorbers	model	article number	
301 x 183 cm	single axle							
		1500	1117	468 x 196 x 70	33.02 (13")	✓ / ✓ / ✓	SHP O2 15-30-18.1	24361
	twin axle							
	2000	1557	468 x 196 x 70	33.02 (13")	✓ / ✓ / ✓	SHP O2 20-30-18.2	24363	
	2700	2227	468 x 196 x 70	33.02 (13")	✓ / ✓ / ✓	SHP O2 27-30-18.2	24364	
	3500	3000	468 x 196 x 70	33.02 (13")	✓ / ✓ / ✓	SHP O2 35-30-18.2	24444	
401 x 183 cm	twin axle							
		2000	1492	568 x 196 x 70	33.02 (13")	✓ / ✓ / ✓	SHP O2 20-40-18.2	24374
	2700	2181	568 x 196 x 70	33.02 (13")	✓ / ✓ / ✓	SHP O2 27-40-18.2	24375	
	3000	2445	568 x 196 x 70	33.02 (13")	✓ / ✓ / ✓	SHP O2 30-40-18.2	24376	
401 x 203 cm	single axle							
		1800	1267	568 x 216 x 70	33.02 (13")	✓ / ✓ / ✓	SHP O2 18-40-20.1	24356
	twin axle							
		2000	1452	568 x 216 x 70	33.02 (13")	✓ / ✓ / ✓	SHP O2 20-40-20.2	24378
	2700	2142	568 x 216 x 70	33.02 (13")	✓ / ✓ / ✓	SHP O2 27-40-20.2	24379	
	3000	2392	568 x 216 x 70	33.02 (13")	✓ / ✓ / ✓	SHP O2 30-40-20.2	24380	
	3500	2875	568 x 216 x 70	33.02 (13")	✓ / ✓ / ✓	SHP O2 35-40-20.2	24381	
511 x 213 cm *	twin axle							
		3500	2593	666 x 220 x 72	33.02 (13")	✓ / ✓ / ✓	SHP O2 35-52-22.2	25716
611 x 213 cm *	twin axle							
		3500	2497	764 x 220 x 72	33.02 (13")	✓ / ✓ / ✓	SHP O2 35-62-22.2	25706

* Accessories on request. Can only be upgraded with aluminum side wall and angle lever locks.

SySTEMA® extensions - flat bed trailer and platform trailer

product	product
¹ side panel GALVALUME® - 35 cm high, double-walled	flat cover
side panel made of aluminum - 35 cm high	high cover & high frame - 100 cm 125 cm 150 cm 175 cm
side panel extension GALVALUME® - 35 cm high, double-walled	Telescopic loading stands
side panel extension made of aluminum - 35 cm hoch	loading ramps for motorcycles with transport rail
mesh sides - 66 cm high	loading ramps for quad with transport rail
ladder rack - 35 cm high	ramps-set made of aluminum with transport rail
front rail - 10 cm high	
side rail - 10 cm high	

1 GALVALUME = ALUMINUM / ZINC COATING

ORIGINAL STEMA ACCESSOIRES



For more STEMA accessories please look at the online shop: www.stema.de



flat cover



load securing net



fastening belts



cradle-style wheel holder



anti-theft protection



loading stands



chock block



red nose



adapter

Pictures are classic examples.

Your STEMA Partner

STEMA Metalleichtbau GmbH

Riesaer Straße 50
01558 Großenhain

Phone +49 (0) 3522 30 94 0

www.stema.de
info@stema.de

STEMA reserves errors and changes. Measures and weights are approximations. Pictures are classic examples and partly contain accessories. Products are subject to continuous technical changes. No liability accepted for printing errors.

